

Multi-channel(4 channel / 2 channel) modular type PID control

■ Features

- Multi-channel(4 channel/ 2 channel) simultaneous controlling possible
- High-speed sampling cycle(4 channel: 100ms, 2 channel: 50ms)
- **No communication and power supply for expansion modules required by using side connectors: Max. 31 units (124 channels / 62 channels)**
- Input channel isolated design(Dielectric strength 1,000 VAC)
- Heating/Cooling simultaneous controlling
- Allows parameter setting by USB port of PC
 - : Free download the integrated device management program(DAQMaster)
 - ×Communication converter, sold separately
 - : SCM-WF48(Wi-Fi to RS485/USB communication converter(available soon), SCM-US(USB to Serial converter), SCM-38I(RS-232C to RS485 converter), SCM-US48I(USB to RS485 converter)
- Parameter setting by SCM-US without power/wiring
- Easy maintenance via connector type connection
 - : Sensor input connector, control output connector, power/communication connector
- Multi input / Multi range
- Heater disconnection function(CT input) × CT, sold separately: CSTC-E80LN, CSTC-E200LN

Line-up



 Please read "Caution for your safety" in operation manual before using.



■ Manual

- Visit our website (www.autonics.com) to download user manual and communication manual.
- User manual describes for specifications and function, and communication manual describes for RS485 communication (Modbus RTU protocol) and parameter address map data.

■ Integrated device management program(DAQMaster)

- DAQMaster is a integrated device management program for convenient management of parameters and multiple device data monitoring.
- Visit our website (www.autonics.com) to download user manual and integrated device management program.

< Computer specification for using software >

Item	Minimum requirements
System	IBM PC compatible computer with Intel Pentium III or above
Operating system	Microsoft Windows 98/NT/XP/Vista/7
Memory	256MB or more
Hard disk	More than 1GB of free hard disk space
VGA	1024×768 or higher resolution display
Others	RS-232 serial port(9-pin), USB port

< DAQMaster screen >





■ Ordering information

Item	Channel	Option input/output	Power supply	Control output	Module type				
TM	4	-	N	2	R	B	B	Basic module	
							E	Expansion module ^{※1}	
TM	4	-	N	2	R	B	2 Channel	R	Relay output
							4 Channel	C	Current or SSR drive voltage output selectable
							2 Channel	R	Relay output
							4 Channel	S	SSR drive voltage output
TM	4	-	N	2	R	B	2	24VDC	
							2 Channel	2	Alarm1+Alarm2 Relay output
							4 Channel	4	Alarm1+Alarm2+Alarm3+Alarm4 Relay output
							4 Channel	N	None(×No auxiliary input/output)
TM	4	-	N	2	R	B	2	2 Channel	
							4	4 Channel	
TM								TM	Multi-channel modular temperature controller

※Make sure to purchase both expansion module and basic module together because power supply/communication terminals are provided with basic modules only.

Multi-Channel Module type PID Control

Specifications

Series	TM2-22RB	TM2-42RB	TM2-22RE	TM2-42RE	TM2-22CB	TM2-42CB	TM2-22CE	TM2-42CE	TM4-N2RB	TM4-N2RE	TM4-N2SB	TM4-N2SE	
Channel	2 Channel (Each channel insulated-Dielectric strength 1,000VAC)								4 Channel (Each channel insulated-Dielectric strength 1,000VAC)				
Power Supply	24VDC												
Allowable voltage range	90 to 110% of rated voltage												
Power consumption	Max. 5W												
Display type	Non-display type Parameter setting & monitoring with external devices (PC or PLC)												
Input type	RTD	DPT100Ω, JPT100Ω 3 wire (allowable line resistance max. 5Ω per a wire)											
	Thermocouple	K, J, E, T, L, N, U, R, S, B, C, G, PLII (13types)											
Display accuracy	RTD	(PV ±0.5% or ±1°C, select the higher one) ±1digit Max.											
	Thermocouple※1												
	CT input												±5% F.S. ±1digit Max.
	Current output	±1.5% F.S. ±1digit Max.								—			
Influence of temperature※2	RTD	(PV ±0.5% or ±2°C, select the higher one) ±1digit Max.(In case of thermocouple input, it is ±5°C at -100°C below.) • Thermocouples L, U, C, G, R, S, B: (PV ±0.5% or ±5°C, select the higher one) ±1digit Max.											
	Thermocouple												
Control output	Relay	250VAC 3A 1a				—				250VAC 3A 1a		—	
	SSR	—				12VDC ±3V 30mA Max.				—		22VDC ±3V30mA Max.	
	Current	—				DC 4-20mA or DC 0-20mA selectable(load 500Ω Max.)				—		—	
Option output	Relay	250VAC 3A 1a										—	
	Communication	RS485 Communication output (Modbus RTU)											
Option input	CT input	0.0-50.0A(Primary current measurement range) ※CT ratio = 1/1000								—			
	Digital input	• Contact input: ON Max. 1kΩ, OFF Min. 100kΩ • Non-contact input: ON Max. 1.5V residual voltage, OFF Max. 0.1mA leakage current • Outflow current: Approx. 0.5mA								—			
Control method	Heating, cooling	ON/OFF control mode, P, PI, PD, PID control mode											
	Heating&cooling												
Hysteresis	1 to 100°C/°F (0.1 to 100°C/°F) variable								1 to 100 digit				
Proportional band (P)	0.1 to 999.9°C/°F												
Integral time (I)	0 to 9999 sec.												
Derivative time (D)	0 to 9999 sec.												
Control period (T)	0.1 to 120.0 sec. (only relay output and SSR drive voltage output type)												
Manual reset value	0.0 to 100.0%												
Sampling period	50ms (2 channel synchronous sampling)								100ms (4 channel synchronous sampling)				
	Dielectric strength 1,000VAC 50/60Hz for 1 min. (between power source terminal and input terminal)												
Vibration	0.75mm amplitude at frequency of 5 to 55Hz(for 1 min.) in each of X, Y, Z directions for 2 hours												
Relay life cycle	Mechanical	Min. 10,000,000 operations											
	Electrical	Min. 100,000 operations (250VAC 3A resistance load)											
Insulation resistance	100MΩ(at 500VDC megger)												
Noise resistance	±0.5kV the square wave noise (pulse width: 1us) by the noise simulator												
Environment	Ambient temperature	-10 to 50°C, storage: -20 to 60°C											
	Ambient humidity	35 to 85%RH, storage: 35 to 85%RH											
Accessory	Expansion connector												
	Power / communication connector (※Basic module only)												
Insulation type	Double insulation or reinforced insulation (Mark: □). Dielectric strength between the measuring input part and the power part: 1kV)												
Approval	  												
Unit weight	Approx. 144g	Approx. 152g	Approx. 135g	Approx. 143g	Approx. 139g	Approx. 148g	Approx. 130g	Approx. 139g	Approx. 174g	Approx. 166g	Approx. 160g	Approx. 152g	

※1: In case of thermocouple K, T, N, J, E at -100°C below and L, U, Platinell, it is ±2°C ±1digit Max.

In case of thermocouple B, display accuracy cannot be ensured under 400°C.

In case of thermocouple R, S at 200°C below and thermocouple C, G, it is 3°C ±1digit Max.

※2: Applied when used out of range 23 ±5°C.

※Environment resistance is rated at no freezing or condensation.

(A)	Photo electric sensor
(B)	Fiber optic sensor
(C)	Door/Area sensor
(D)	Proximity sensor
(E)	Pressure sensor
(F)	Rotary encoder
(G)	Connector/Socket
(H)	Temp. controller
(I)	SSR/ Power controller
(J)	Counter
(K)	Timer
(L)	Panel meter
(M)	Tacho/ Speed/ Pulse meter
(N)	Display unit
(O)	Sensor controller
(P)	Switching mode power supply
(Q)	Stepper motor& Driver&Controller
(R)	Graphic/ Logic panel
(S)	Field network device
(T)	Software
(U)	Other

TM Series

■ Connections and block diagram

● TM2 Series

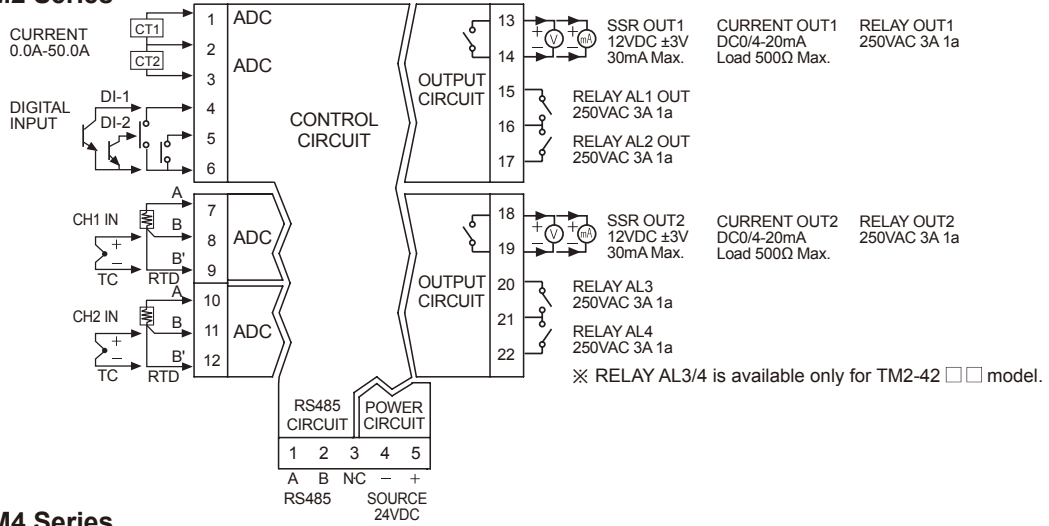

● TM4 Series

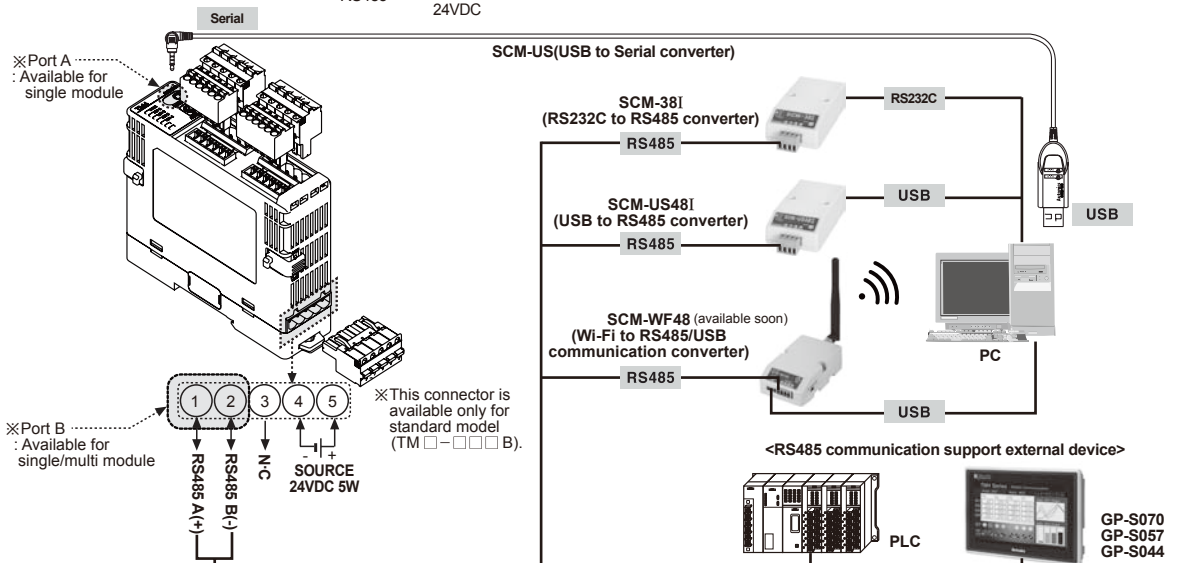
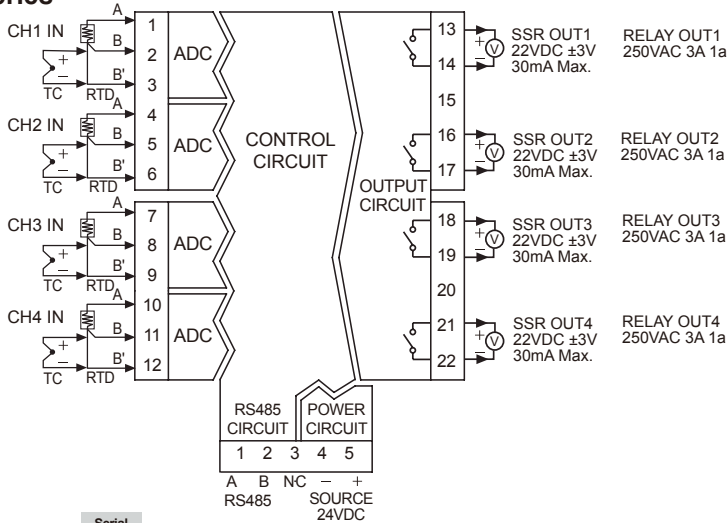

Multi-Channel Module type PID Control

■ Dimensions

(unit: mm)

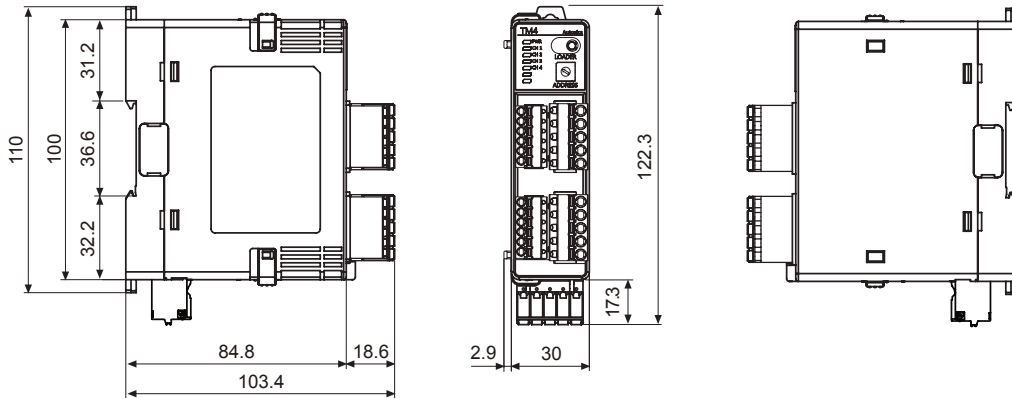

■ Installation

● Connector connection

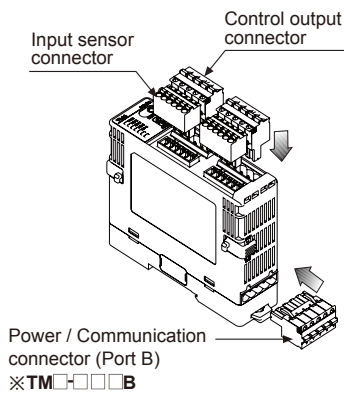

● Multi module connection

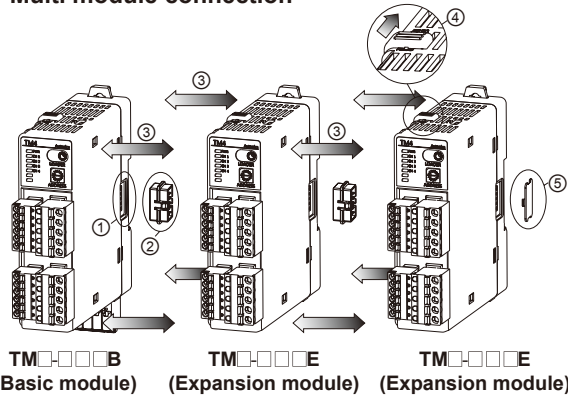

- ※① Remove END cover for both basic modules and expansion modules.
- ② Insert expansion connectors.
- ③ Connect an expansion module without space.
- ④ Fix the LOCK switch by pushing it in the LOCK direction.
- ⑤ Mount the END cover at each side.

※Up to 30 expansion modules can be connected to a basic module. Use an adequate power supply system for the power input specifications and overall capacity. [Maximum power (155W=31ea X 5W) is required when connecting 31 units]

● Bolt Inserting

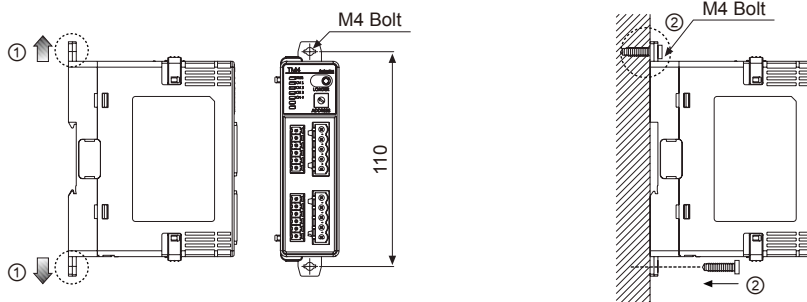

① Pull each Rail Lock switch up and down.

② Insert the bolts to fix. (Tightening torque is 0.5N·m to 0.9N·m.)

(A)	Photo electric sensor
(B)	Fiber optic sensor
(C)	Door/Area sensor
(D)	Proximity sensor
(E)	Pressure sensor
(F)	Rotary encoder
(G)	Connector/Socket
(H)	Temp. controller
(I)	SSR/Power controller
(J)	Counter
(K)	Timer
(L)	Panel meter
(M)	Tacho/Speed/Pulse meter
(N)	Display unit
(O)	Sensor controller
(P)	Switching mode power supply
(Q)	Stepper motor& Driver&Controller
(R)	Graphic/Logic panel
(S)	Field network device
(T)	Software
(U)	Other

TM Series

● DIN Rail Installation

[Installation method]

- Put the top edge of the rail Lock on the top edge or the DIN rail.
- Push the module body in while pressing down.

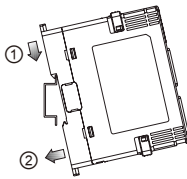

[Removal method]

- Press down the module body.
- Pull the module body forward.

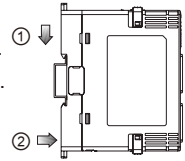

Using END PLATE(Sold separately, Not available from Autonics), Fix firmly to attach

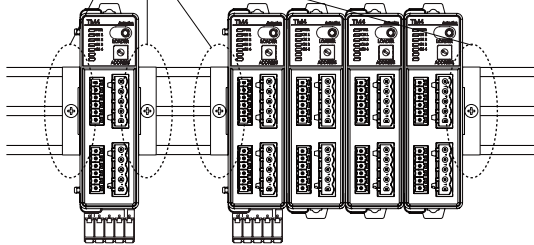

※Make sure to install the unit vertically to the ground.

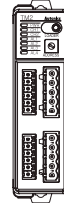

Vertical Installation
(O)

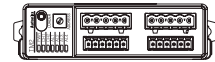

Horizontal Installation
(X)

■ Parts description

● TM2 Series

● TM4 Series

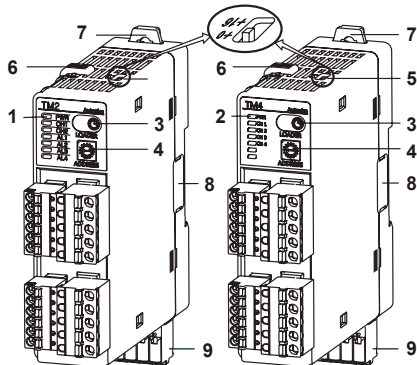

3. PC loader port(Port A)

Integrated device management program (DAQMaster, free download on our site) is for setting parameter by PC through USB to Serial converter (SCM-US, sold separately).

4. Communication address setting switch(SW1)

Used to set communication address.

5. Communication address group change switch(SW2)

When communication address is over 16, select +16.

Ex) For setting 20 address, set the communication address group change switch (SW) as +16 and set the communication address setting switch (SW1) as 4.

6. Lock switch

Used for fixing units to DIN rail or to the wall

7. Rail Lock

Used for fixing each module when connecting module units. (up/down side)

8. END Cover: Remove it when connecting each module.

9. Power supply / communications connector(PortB)

Only Basic module TM□-□2□B

1. Display LED(TM2 Series)

Status / Display LED	Initial power on ^{*1}	Control output	Alarm output				Auto tuning ^{*2}
			N.O. Alarm occurred		N.C. Alarm occurred		
			OFF(OPEN)	ON(CLOSE)	OFF(CLOSE)	ON(OPEN)	
PWR LED ^{*3}	Green	Green	—	—	—	—	Green
CH1 LED	2400bps-Flashing	ON-RED	—	—	—	—	Flashing
CH2 LED	4800bps-Flashing	ON-RED	—	—	—	—	Flashing
AL1 LED	9600bps-Flashing	ON-Yellow ^{*4}	Light OFF	Light ON	Light OFF	Light ON	Light OFF
AL2 LED	19200bps-Flashing	ON-Yellow ^{*5}	Light OFF	Light ON	Light OFF	Light ON	Light OFF
AL3 LED	38400bps-Flashing	—	Light OFF	Light ON	Light OFF	Light ON	Light OFF
AL4 LED	—	—	Light OFF	Light ON	Light OFF	Light ON	Light OFF

2. Display LED(TM4 Series)

Status / Display LED	Initial power on ^{*1}	Control output	Auto tuning ^{*2}
PWR LED ^{*3}	Green	Green	Green
CH1 LED	2400bps-Flashing	ON-RED	Flashing
CH2 LED	4800bps-Flashing	ON-RED	Flashing
CH3 LED	9600bps-Flashing	ON-RED	Flashing
CH4 LED	19200bps-Flashing	ON-RED	Flashing
	38400bps-Flashing	—	—

※1: In case of initial power on, default communication speed will be flashing for 5 sec. (1 sec. cycle).

※2: Each CH3 LED will be flashing during auto tuning (1 sec. cycle).

※3: Power LED will be flashing while communicating with external units (1 sec. cycle).

※4: Light ON when control type for CH1 is heating & cooling type and cooling output is provided.

※5: Light ON when control type for CH2 is heating & cooling type and cooling output is provided.

Multi-Channel Module type PID Control

Input sensor type and temperature range

Input sensor	No.	Dot	Display	Input range (°C)	Input range (°F)
Thermocouple	K(CA)	0	K(CA).H	-200 to 1350	-328 to 2462
		1	K(CA).L	-200.0 to 1350.0	-328.0 to 2462.0
	J(IC)	2	J(IC).H	-200 to 800	-328 to 1472
		3	J(IC).L	-200.0 to 800.0	-328.0 to 1472.0
	E(CR)	4	E(CR).H	-200 to 800	-328.0 to 1472
		5	E(CR).L	-200.0 to 800.0	-328.0 to 1472.0
	T(CC)	6	T(CC).H	-200 to 400	-328 to 752
		7	T(CC).L	-200.0 to 400.0	-328.0 to 752.0
	B(PR)	8	B(PR)	0 to 1800	32 to 3272
	R(PR)	9	R(PR)	0 to 1750	32 to 3182
	S(PR)	10	S(PR)	0 to 1750	32 to 3182
	N(NN)	11	N(NN)	-200 to 1300	-328 to 2372
	C(TT) ^{※1}	12	C(TT)	0 to 2300	32 to 4172
	G(TT) ^{※2}	13	G(TT)	0 to 2300	32 to 4172
	L(IC)	14	L(IC).H	-200 to 900	-328 to 1652
		15	L(IC).L	-200.0 to 900.0	-328.0 to 1652.0
	U(CC)	16	U(CC).H	-200 to 400	-328 to 752
		17	U(CC).L	-200.0 to 400.0	-328.0 to 752.0
Platinel II	18	PLII	0 to 1400	32 to 2552	
RTD	JPt 100Ω	19	JPt100.H	-200 to 600	-328 to 1112
		20	JPt100.L	-200.0 to 600.0	-328.0 to 1112.0
	DPt 100Ω	21	DPt100.H	-200 to 600	-328 to 1112
		22	DPt100.L	-200.0 to 600.0	-328.0 to 1112.0

※1: C(TT): Same as existing W5(TT).

※2: G(TT): Same as existing W(TT).

※Default: K(CA).H

Error indication

	Input sensor open error	Over temperature range
PWR LED	Red ON	
CH1 LED	RED Flashing (for 0.5 sec.)	
CH2 LED	RED Flashing (for 0.5 sec.)	
CH3 LED ^{※1}	RED Flashing (for 0.5 sec.)	
CH4 LED ^{※1}	RED Flashing (for 0.5 sec.)	
Communication output (decimal)	'31000' output	'30000 (upper limit)' output, '-30000 (lower limit)' output
Dedicated program	'OPEN' indication	'HHHH (upper limit)' indication, 'LLLL (lower limit)' indication

※1: Only for TM4 Series(4CH).

Communication setting

A function for external parameter setting & monitoring with PC or PLC.

Interface

Application Standard	Compliance with EIA RS 485
Max. connection	31 units (communication address setting: 01 to 31)
Communication type	Two wire, Half Duplex
Synchronization method	Asynchronous
Communication distance	Max. 800m
Communication speed(bps)	2400, 4800, 9600(default),19200, 38400
Communication response time	5 to 99ms
Start Bit	1bit(fixed)
Stop Bit	1bit, 2bit(default)
Parity Bit	None(default), Odd, Even
Data Bit	8bit(fixed)
Protocol	Modbus RTU

※Overlapped address setting is not allowed on the same communication line. Twisted Pair wires(for RS485 communication) must be used for communication cable.

Communication speed indication

Current communication speed will be flashing in case of initial power ON for 5 sec. (1 sec. cycle).

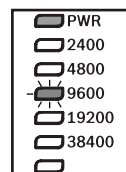

※One module communication is allowed for Port A. Communication speed is fixed to 9600bps.

※Multiple communication is allowed for Port B. It is required to reset controller's Power(Power OFF→Power ON) after changing communication speed.

※Simultaneous monitoring can not be done for Port A and B since Port A is for parameter setting only.

※If connects communication through Port A, Port B will be disconnected communication automatically.

TM Series

● Communication address setting

Set the communication address using SW1 and SW2.

Setting range is 01 to 31. (※In case setting 00, communication is not available.)

SW1		SW2															
		0	1	2	3	4	5	6	7	8	9	A	B	C	D	E	F
+0	+16	00	01	02	03	04	05	06	07	08	09	10	11	12	13	14	15
	+0	16	17	18	19	20	21	22	23	24	25	26	27	28	29	30	31

※Default- SW1: 1, SW2: +0

■ Sold separately

◎ Communication converter

● SCM-WF48 (available soon)

(Wi-Fi to RS485/USB communication converter)

CE (pending)



● SCM-38I

(RS232C to RS485 converter)

CE



● SCM-US48I

(USB to RS485 converter)

CE



● SCM-US

(USB to Serial converter)

CE



◎ Current transformer(CT)

● CSTC-E80LN

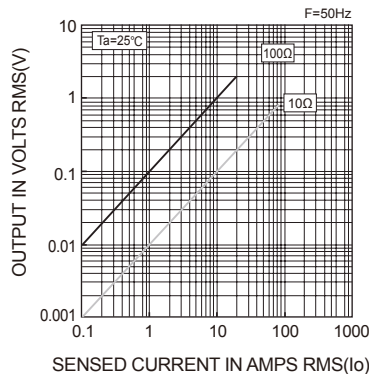
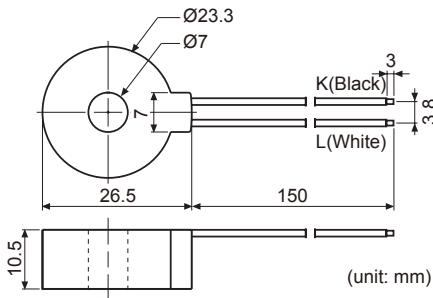

- Max. load current: 80A(50/60Hz)
- ※Max. load current for TM Series is 50A.
- Current ratio: 1/1000
- Wire wound resistance: $31\Omega \pm 10\%$

● CSTC-E200LN

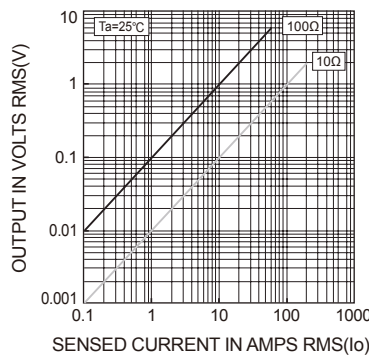
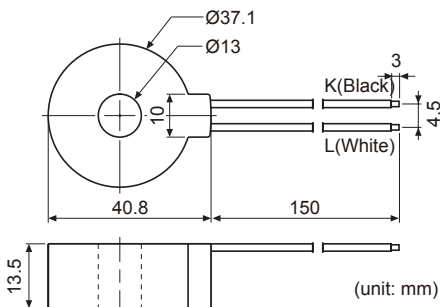

- Max. load current: 200A(50/60Hz)
- ※Max. load current for TM Series is 50A.
- Current ratio: 1/1000
- Wire wound resistance: $20\Omega \pm 10\%$

※Do not supply primary current in case that CT output is open. High voltage will be generated in CT output.

※The current for above two CTs is 50A same but inner hole sizes are different. Please use this your environment.

Multi-Channel Module type PID Control

■ Proper usage

◎ Simple failure diagnosis

- **When display LED is flashing every 0.5 sec. or when error message is indicated on external units**
 - It represents input sensor open error. Cut off the power of controller and check input sensor connection.
If sensor is properly connected, disconnect sensor line from the controller and short the input terminal (+) / (-). Then, make sure that current indoor temperature is indicated. If current indoor temperature is properly indicated, it represents no errors detected. If external unit displays 'HHHH' or 'LLLL', please contact our A/S center.
(Current indoor temperature checking is available only if selecting thermocouple type.)
 - Make sure proper input sensors are selected.
- **When no output is operated**
 - Check output display LED at the front. In case output display LED does not work properly, please check each parameter setting again. In case output display LED works properly, disconnect the output terminal and check controller's output type (Relay contact, SSR, Current) again.
- **When external units receive no response or error data**
 - Check communication converter first.
 - Do not install the unit with overlapping communication converter lines and AC power supply lines.
 - Use separate power supply (24VDC) for communication converter if possible.
 - Strong external noise could be a possible cause for this symptom. Please contact our A/S center. In addition, analyze the main cause that triggers strong noise and take measures to prevent it. Even though this unit complies with proper noise resistance standards, consistent noise induction could affect internal circuit break.
- **When communication does not work properly**
 - Check converter's power supply and connection.
 - Check communication setting.
 - Check main body's connections to external units.

◎ Caution for using

- Use DC power only.
- Keep the ambient temperature -10°C to 50°C.
- For more accurate controlling, start temperature controlling approx. 20 minutes later after connecting input sensors and supplying power.
- In case display accuracy does not meet the specification, check Input Bias parameter first.
- Power switch or a circuit breaker must be installed for proper application.
- Make sure that the power switch or a circuit breaker installed near operators.
- This unit is solely allowed for temperature controlling application. Do not apply this unit as a voltage meter or current meter.
- When line extension is required, please use specified compensation line. If not, there occurs temperature difference at the joint part between thermocouples and extension lines.
- In case of using RTD, line connection must be done with 3 wires. When line extension is required, use the same wire with material, thickness and length. Different line resistance may cause temperature difference.
- Make sure controller's line connection must be separated from high voltage line or power supply line in order to prevent induced noise.
- If it is required that power supply line should be connected near input signal line, use line filter on controller's power supply line and input signal line must be shielded.
- Avoid installing controllers adjacent to high frequency noise generating units including high frequency soldering machine, high frequency sewing machine, and high capacity SCR controllers and motors.
- Avoid using the unit near radio, TV or wireless machines that may cause high frequency interference.
- When changing input sensors, power off the controller first. Connect input sensors as specified and supply the power again. Then, change & download related parameters using PC loader program.
- Use (-) driver screws (2mm) or use plastic driver screws. If not, it might cause product damage.
- Twist Pair wires must be used for communication cable. Connect Ferrite Bead at each end of line in order to reduce the effect of external noise.
- Avoid installing the unit with overlapping communication line and AC power line together.
- Draw a draft while using the controllers. In case of installing at a closed area, please take measures for ventilation.
- Installation environment
 - It shall be used indoor.
 - Altitude Max. 2000m.
 - Pollution Degree 2
 - Installation Category II.

(A)	Photo electric sensor
(B)	Fiber optic sensor
(C)	Door/Area sensor
(D)	Proximity sensor
(E)	Pressure sensor
(F)	Rotary encoder
(G)	Connector/Socket
(H)	Temp. controller
(I)	SSR/ Power controller
(J)	Counter
(K)	Timer
(L)	Panel meter
(M)	Tacho/ Speed/ Pulse meter
(N)	Display unit
(O)	Sensor controller
(P)	Switching mode power supply
(Q)	Stepper motor& Driver&Controller
(R)	Graphic/ Logic panel
(S)	Field network device
(T)	Software
(U)	Other