



Operating Manual



FOX-23AF



FOX-2003S

1 Caution for safety

Read carefully this instruction manual before use and use the product properly.

※ The specifications, appearance and dimension may be changed for improvement of performance without a prior notice.

WARNING

1. This product is not made as a safety device, so when it is used for a control of devices feared to cause casualties, damages to the peripheral devices or huge property loss, the double safety devices should be arranged before use.
2. Avoid connecting lines, checking and repairing the products while power is supplied.
3. Connect power after making sure the terminal number.
4. Never disassemble modify, improve or repair the product.

CAUTIONS

- Be well-informed of how to use, safety regulations, warnings, etc before installation of this device and apply it to the extent of the defined specifications and relevant capacity without fail.
- Avoid wiring or installation to a motor or solenoid with a large inductive load.
- Use a shielded cable for extension of the sensor and ensure not to make it longer than the necessity.
- Ensure not to use the parts generating arc when switching at the same power source or near to it.
- Keep the power cable away from a high-tension power line and ensure not to install it at a place with serious oil and dirt.
- Avoid strong magnetic field or serious noise, vibration or impact.
- Keep away from the place where strong alkaline or acid material is directly released and use an independent pipe line.
- When it is installed at kitchen, ensure not to pour water directly over the product for cleaning.
- Keep the sensor cable away from signal line, power source, power line or loaded line and use an independent pipe line.
- Note that the mark of ⚠ in terminal connection diagram is the safety expression for warnings or cautions.
- Avoid using the product close to the device generating noises(high frequency welder, high frequency sewing machine, high frequency radio, large capacity SCR Controller, etc).
- The use in any way other than what is instructed by the manufacturer may cause injury or property loss.
- It is not a toy and keep it out of reach of children's hand.
- The installation of the device should be performed by an expert or a qualified personnel without fail.
- We shall not take any responsibility for the damage caused by non-compliance with the above-mentioned warnings or cautions or by any consumer's mistake.

DANGER

Attention, Danger related to electric shock

- Electric shock –Do not touch AC terminal during application of electric current. It may cause electric shock.
- Cut the power supply without fail during checking the input power.

2 Model

Model	Sensor	Controlled output	Temperature range	Functions
FOX-23AF (Cooler only)	NTC	Relay contact (3EA)	-55.0℃ ~+99.9℃	COMP control Defrost control FANcontrol(5A)
FOX-2003S (Cooler only)	NTC	Relay contact (3EA)	-55.0℃ ~+99.9℃	COMP control Defrost control FANcontrol

3 PART NAME

External shape & each name of part

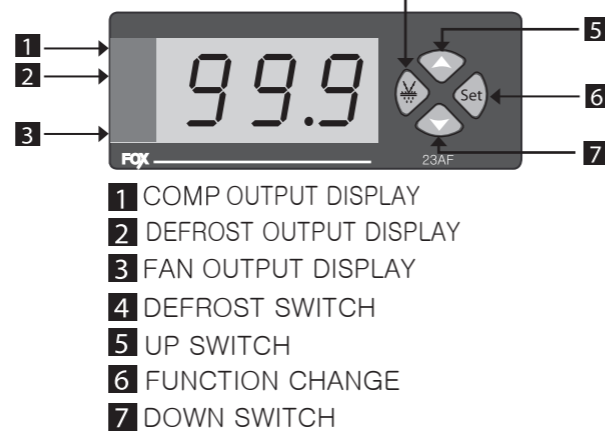

User's mode changing(Temperature setting)

- How to change the setting temp. for Main output

Set If press it once, the setting value is flickered.

or the value can be UP & DOWN with this key.

- Mode setting for user

Set A key to enter to installer mode if press for more than 5 sec. change with these keys. Set

4 Terminal connection diagram

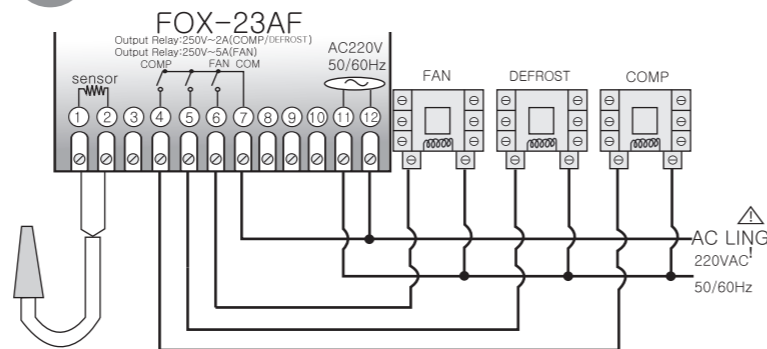

- ※ Output
- COMP/DEFROST relay connection capacity is less than 250VAC 2A.
 - FAN relay connection capacity is less than 250VAC 5A.

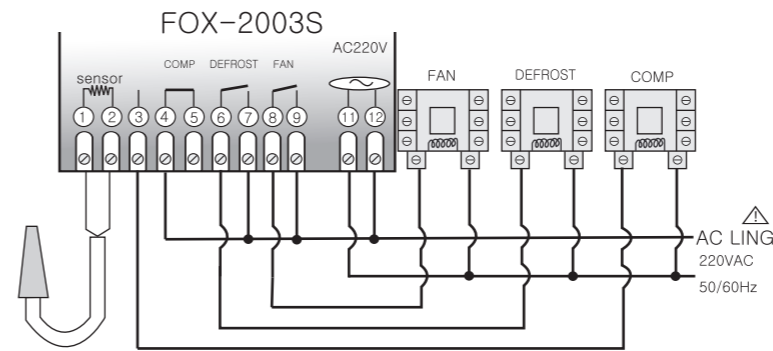

- ※ Output
- 250VAC 2A
 - Please make use of the power relay or magnet surely.

Example for connection of relay

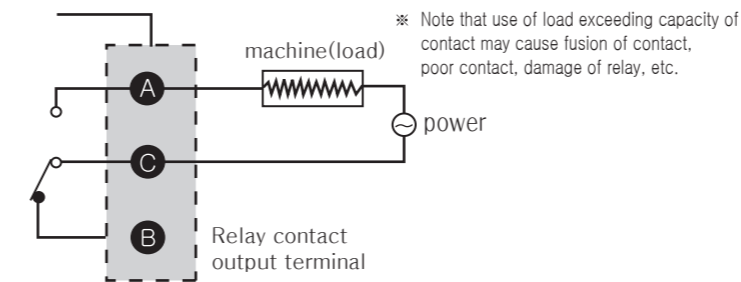

5 EXTERNAL DIMENSION & PANEL SIZE

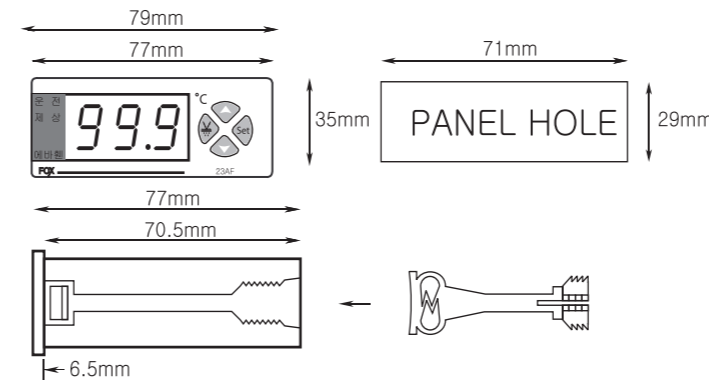

6 Setting value change sequence

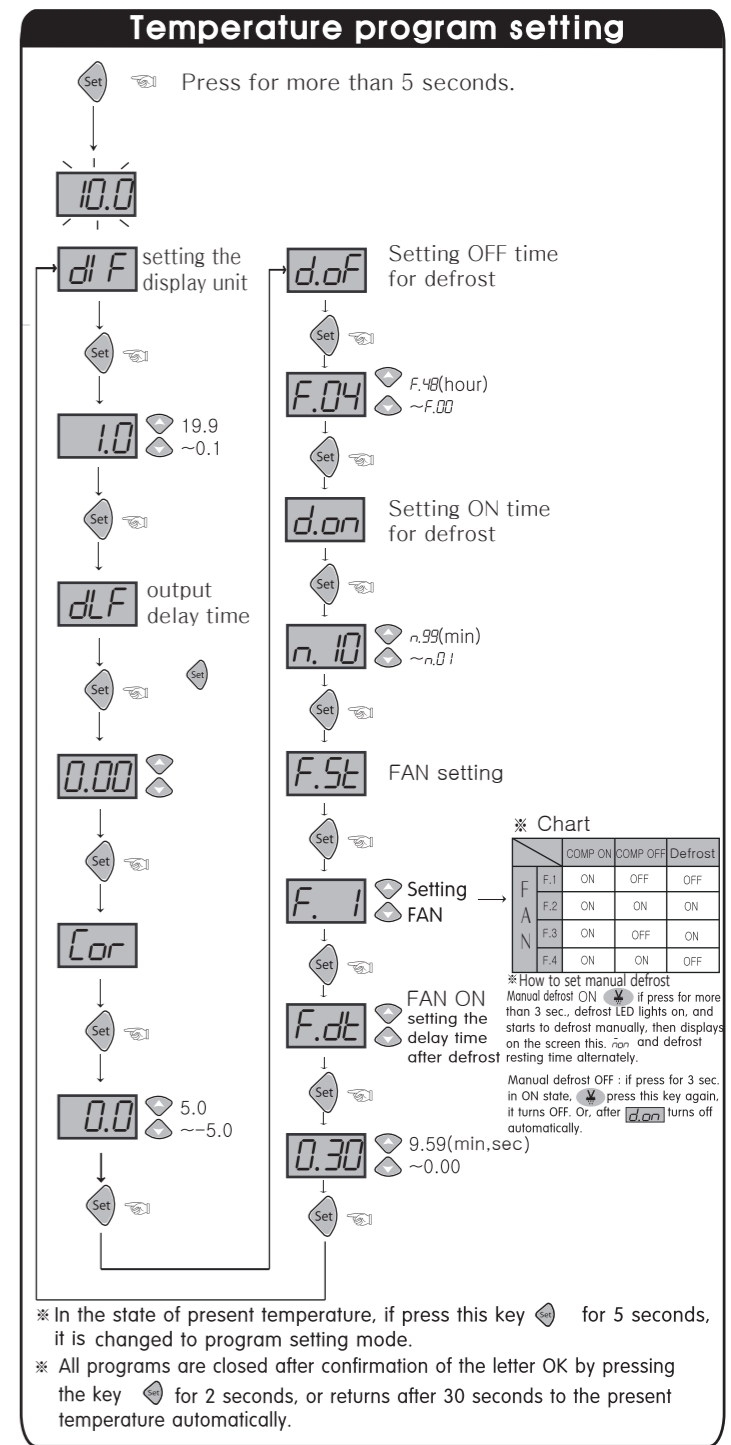
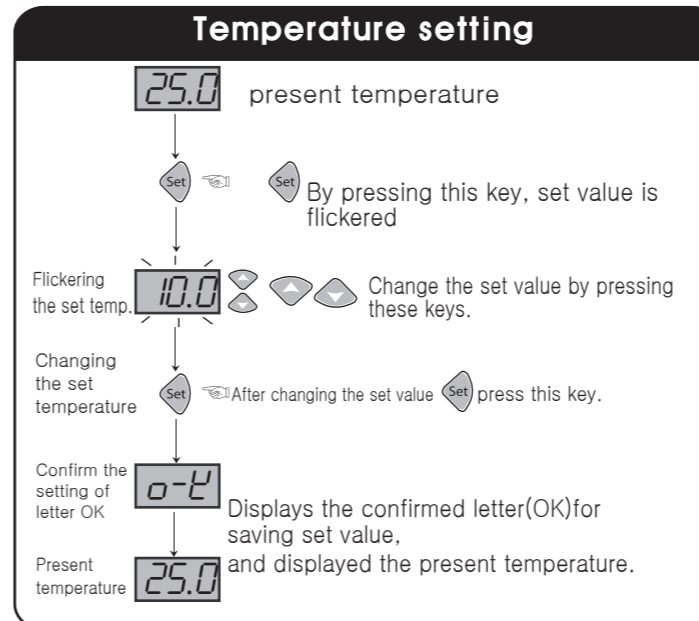

MEMO

7 Detailed manual

dF : Setting for temperature deviation

- In the ON/OFF control, it needs at regular interval between ON and OFF.
- By operating the ON/OFF control frequently, the relay or its output contact can be damaged quickly and it also occurs the hunting (oscillating, chattering) by virtue of external noise. You can make use of the temperature deviation in order to protect its relay or contact and so on.

「Method of temp. deviation when ON/OFF control」

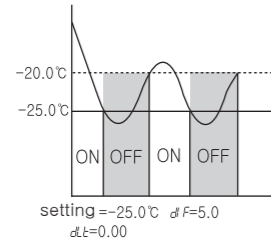

present temp. > setting temp. + temp. deviation
→ output ON

present temp. ≤ setting temp.
→ output OFF

dt : Delay time of the output

- In case of operating the ON/OFF control very often. (Cooler, compressor, etc)
- To protect the operation machinery when re-input of the power supply or momentary stoppage of power supply.

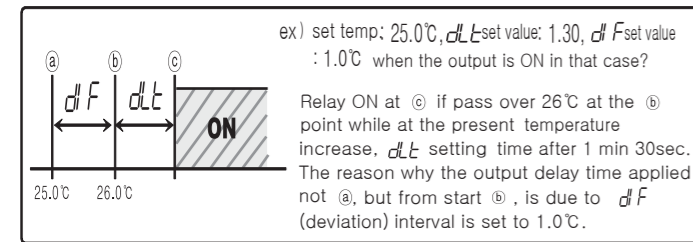

Cor : Correction of the present temperature.

The product itself has no problem, but the correction function for that if temp. differs between an error occurs in the input from outside and basic temp. (ex. mercury thermometer or an existed using thermometer, temperature controller)

ex) real temp. 10.0°C → Cor: 0.0 → -2.0 correction → 10.0°C display
display 12.0°C (corrected present temperature)

dof : Defrost OFF time

- Setting range F.00 ~ F.40 hour
- At the cycle of defrost, starts to defrost

d.on : Defrost ON time

- Setting range n.01 ~ n.99 min
- Defrosting during defrost time,

ex) dof : F.04 (4 hours), if setting d.on : n.10

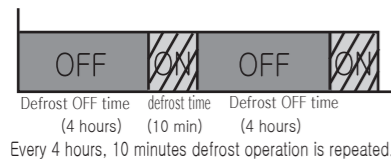

FSt : Fan setting (F.1 ~ F.4) → refer to the flow chart of program setting

F.dt : After defrost, FAN ON delay time

- Setting range 0.00 ~ 9.59 (min, sec)
- ex) F.dt : 0.30(30sec)

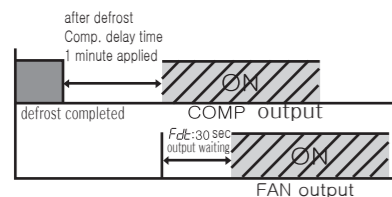

8 TEMPERATURE RANGE & SET VALUE WHEN SHIPMENT

	Functions	Display	Range	Set value when shipment	Remarks
Setting temperature	temperature setting		-55.0~99.9	10.0	
Program setting	deviation temp. setting	dF	0.1~19.9	1.0	output hysteresis setting (+)
	output delay time	dt	0.00~9.59	0.00	(min, sec)
	temp. correction	Cor	-5.0~5.0	0.0	corrects between display and real temp.
	defrost OFF time	d.of	F.00 ~ F.40	F.04	hours unit setting
	defrost ON time	d.on	n.01 ~ n.99	n.10	minute unit setting
	FAN setting	F.St	F.1 ~ F.4	1.01	※ refer to the chart
	after defrost FAN ON delay time	F.dt		0.00~9.59	0.30

9 HOW TO DIAGNOSE A BREAKDOWN

■ Indicating ERROR on using items

● This **Err** is the damage of memory data for various of inner-Data due to be get noised strongly from outside while using this items. Please request us A/S by return. Although our controller is designed as the complementary measures regarding these noise from outside, it is not endurable against these noise with endlessly.

If noise (2kv) disordering become an inflow, the inner-part will be damaged.

● When shows these letter **oEr** (open error), **SEr** (short error) error in sensor. Pls check sensor.

• WARRANTY PERIOD : 1 YEAR FROM THE DATE OF PURCHASE

• RELATED MODEL & OUTPUT

	2001 (sensor:1 EA)	2001D (sensor:1 EA)	2001T (sensor:1 EA)	2001F (sensor:1 EA)	2000TT (sensor:1 EA)
temp. output	1-stage output	2-stage output	3-stage output	4-stage output	controlled by temp & time (for vinyl house only)

sensor	2001 (1 EA)	2002 (1 EA)	2003,2003S, .23AF (1 EA)	2004 (2 EA)	2005 (2 EA)	2006 (2 EA)
temp. output	0	0	0	0	0	temp 1 temp 2 0 0
alarm output	-	0	-	-	0	alarm 1 alarm 2 0 0
defrost output	-	-	0	0	0	-
FAN OUTPUT	-	-	0	0	0	-

ex) Application

- Cooling drive
 - OFF setting : If temperature below 0.0°C
 - ON setting : If temperature above 5.0°C
- Defrost output : Every 10 minutes ON for 4 hours.
- FAN output
 - ON setting : If COMP output ON
 - OFF setting : If COMP output OFF and defrost ON

How to set the set value of temperature controller as the above conditions?

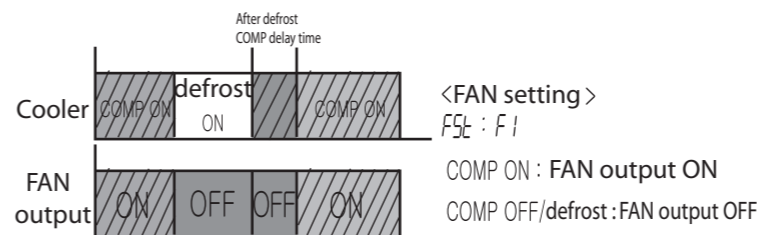
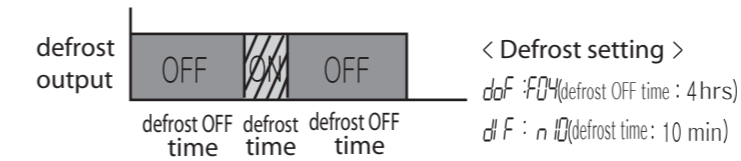
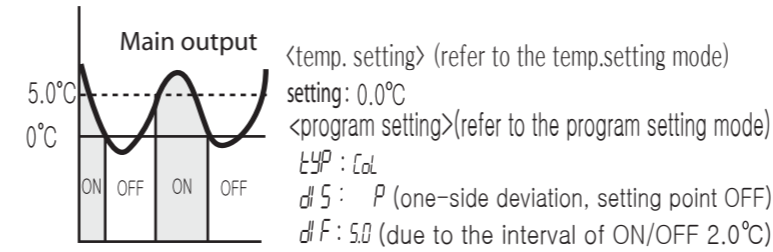

※ Above product's information can be changed to improve its quality without any notification. When using this product, please observe the information of caution & warning due to give rise to disordering.

※ Regarding the English-language manual, please download it at our homepage

■ H.Office : CONOTEC B/D 2nd floor, Yunsan-ro, Geumjeong-gu, Busan, 609-821 Rep. of KOREA
Lab : CONOTEC B/D 3rd floor, 26, Yunsan-ro, Geumjeong-gu, Busan, 609-821 Rep. of KOREA
Factory : CONOTEC B/D B1, 26, Yunsan-ro, Geumjeong-gu, Busan, 609-821 Rep. of KOREA
A/S TEL : +82-51-819-0426
E-mail : conotec@conotec.co.kr
Homepage : www.conotec.co.kr

※ This device is suitable for following environment.
Surrounding temp.: 0°C ~ 60°C
Surrounding humi.: Less than 80%Rh
Rated volt.: 220VAC ±10% 50/60Hz

■ Main Products & Development
- Digital Temperature /Humidity Controller
- Digital Timer, Current/Voltage Meter
- Other Products Development

MEMO